

X-LITE™

DIRECT

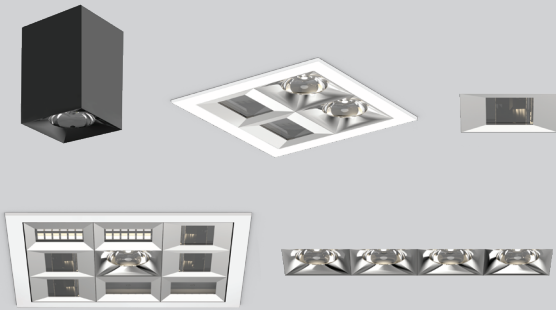

PERFORMANCE

- Up to 70 lm/W
- Multipurpose lighting system
- Multiple lens and housing options
- Recessed, surface, suspended

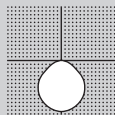

HOUSING OPTIONS

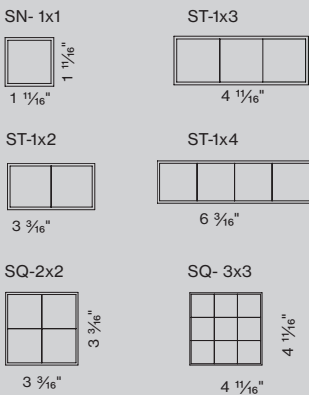

SIDE VIEW

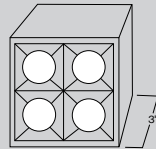

*HEIGHT IS 3" FOR ALL MOUNTING TYPES

DIMENSIONS

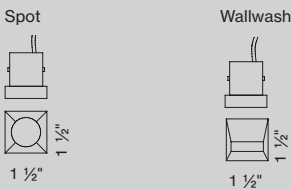

CONFIGURATIONS

Various combinations



[link to video](#)

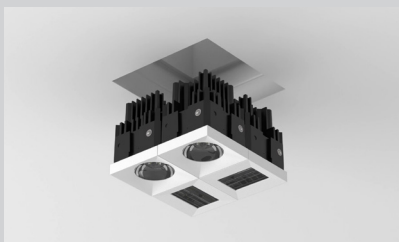

Specification/Instructions

Use the drop downs to select each cells attribute.

1. Select mounting type, housing color, color temperature, and cell color
2. Select Dim Config for cell formation
3. Cell attribute will auto fill depending on selection made for each cell.

Mounting

Housing Color

Color temp

Cell Color

Cell 1	Cell 2
Lens: <input type="text"/>	Lens: <input type="text"/>
DIM Config: <input type="text"/>	DIM Config: <input type="text"/>
NOTES: <input type="text"/>	NOTES: <input type="text"/>

Cell 3	Cell 4
Lens: <input type="text"/>	Lens: <input type="text"/>
DIM Config: <input type="text"/>	DIM Config: <input type="text"/>
NOTES: <input type="text"/>	NOTES: <input type="text"/>

Dim Config.

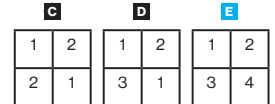

Attributes Key

Use the housing and cell attributes key.

Dim Config.

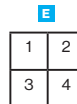

Housing Attributes Key		Cell Attributes Key	
A RANGE	XLITE	A CELL TRIM COLOR	B G
			B M
			C H
			W G
			W M
B PATTERN	SN 1 x 1	C CELL COLOR TEMPERATURE	2 7
	ST 1 x 2		3 0
	ST 1 x 3		3 5
	ST 1 x 4		4 0
	SQ 2 x 2	D CELL DIMMING CHANNEL	C 1
	SQ 3 x 3		C 2
			C 3
			C 4
C MOUNTING	Recessed Trimless R T L		
	Recessed Trim R T R		
	Surface Mounted S U R		
	Pendant P D T		
D HOUSING COLOR	White W H		
	Black B L		
	Gray G R		
	*RTL in white only		
E DIMMING CHANNEL	single channel C 1		
	dual channel C 2		
	three channel C 3		
	four channel C 4		

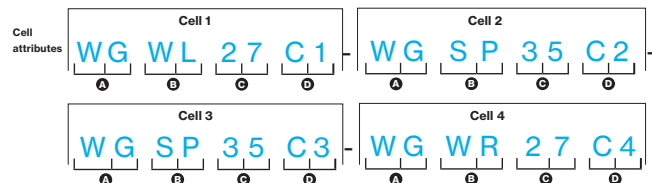
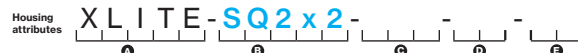
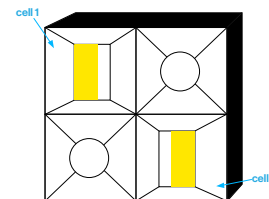

Diagram Example

TOP ROW: Cells 1-2
Cell 1: White Gloss cell color, Wall Wash, light shining left, and 2700K CRI90 temp.
Cell 2: White Gloss, Spotlight, 3500K CRI90 temp.

SECOND ROW: Cells 3-4
Cell 3: White Gloss, Spotlight, 3500K CRI90 temp.
Cell 4: White Gloss cell color, Wall Wash, light shining right, and 2700K CRI90 temp.



BASO

basolighting.com

xalusa.com

X-LITE™

ST1X2



MOUNTING

HOUSING COLOR

*RTL in white only

COLOR TEMP

CELL COLOR

DIM CONFIG.

A	
1	1

B	
1	2

PERFORMANCE

- Up to 70lm/W efficiency
- Multiple lens options
- Recessed, surface & pendant
- CRI > 90

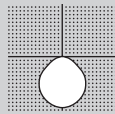

DIAGRAM

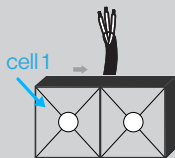

*Spot and Wallwash cells must have separate dimming channels.

Cell 1	Cell 2
LENS <input type="text"/>	LENS <input type="text"/>
DIM CONFIG. <input type="text"/>	DIM CONFIG. <input type="text"/>
NOTES <input type="text"/>	NOTES <input type="text"/>

SINGLE CELL LIGHT DISTRIBUTIONS

SPOT LENS 14°

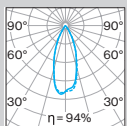

C0 C180
C90 C270
LED array 2.3W / 245lm
106 lm/W

MEDIUM LENS 30°

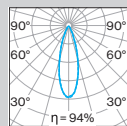

C0 C180
C90 C270
LED array 2.3W / 225lm
98 lm/W

FLOOD LENS 36°

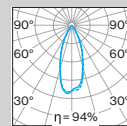

C0 C180
C90 C270
LED array 2.3W / 235lm
101 lm/W

WIDE LENS 57°

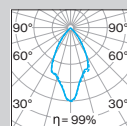

C0 C180
C90 C270
LED array 2.3W / 215lm
93 lm/W

WALL WASH

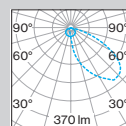

C0 C180
C90 C270
LED array 4.9 W / 365lm
75 lm/W

CONFIGURATIONS

Various combinations



[link to video](#)

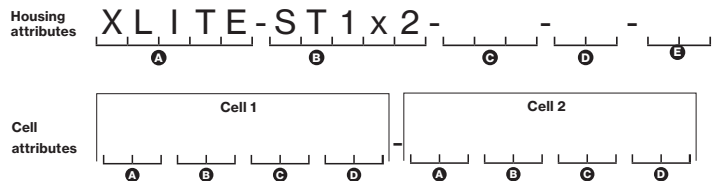
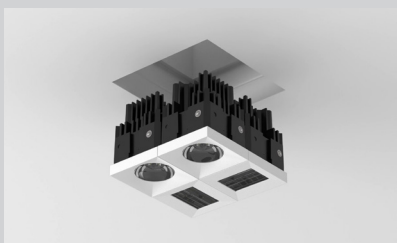

Housing Configuration Code
XLITES20 00

Cell Configuration Code
XCS2 00 0

BASO
basolighting.com
xalusa.com

Power supply

1. LINE CONTROL

X-LITE 0-10V POWER SUPPLIES

	SPOT CELLS	WALLWASH CELLS
1 cell	XLPS - 12 - SP - 001	XLPS - 12 - WW - 001
2 cell	XLPS - 12 - SP - 002	XLPS - 12 - WW - 002
3 cell	XLPS - 12 - SP - 003	XLPS - 12 - WW - 003
4 cell	XLPS - 12 - SP - 004	XLPS - 12 - WW - 004
5 cell	XLPS - 12 - SP - 005	XLPS - 12 - WW - 005
6 cell	XLPS - 12 - SP - 006	XLPS - 12 - WW - 006
7 cell	XLPS - 12 - SP - 007	XLPS - 12 - WW - 007
8 cell	XLPS - 12 - SP - 008	XLPS - 12 - WW - 008
9 cell	XLPS - 12 - SP - 009	XLPS - 12 - WW - 009

*X-Lite configurations with both Spot and Wallwash cells will need two separate remote drivers

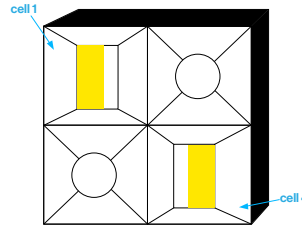

Wiring diagrams

1. LINE CONTROL

0-10V DIM Single Circuit

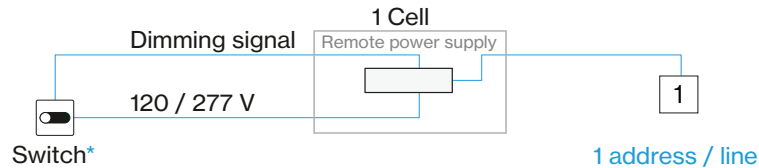

0-10V DIM Dual Circuit

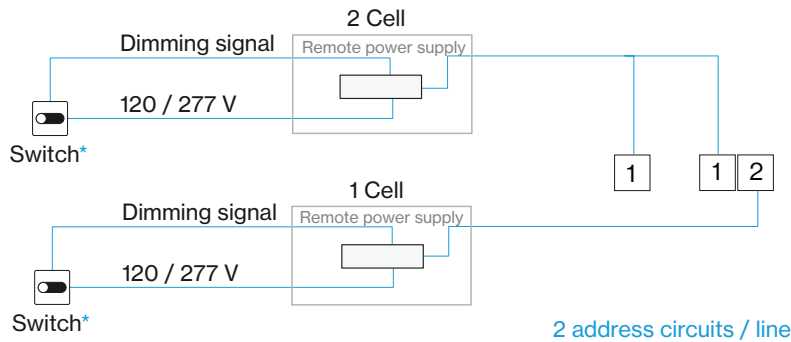

0-10V DIM Tri Circuit

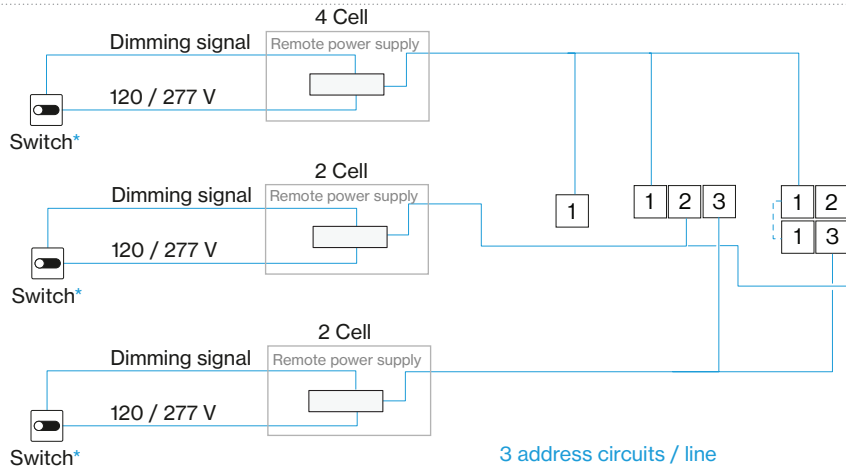

Wiring diagrams continued

0-10V DIM Quad Circuit

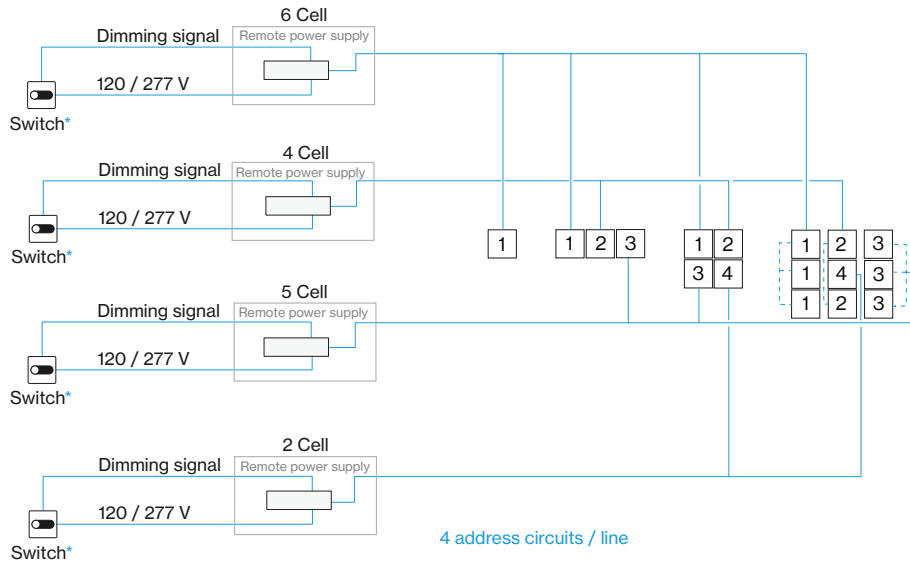

Length range per power supply

POWER SUPPLY

Length A max 150'

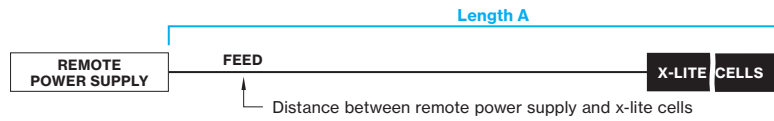

BASO
basolighting.com
xalusa.com

Mounting instructions

Get access to the mounting instructions faster by scanning the QR code.

www.xalusa.com/resources/mounting-instructions

